



Divan d'examen électrique
Gamme SIMPLEX
SIMPLEX-2.0

CARINA
Medical



CE
ISO 9001
ISO 13485

DESCRIPTION TECHNIQUE

- Divan d'examen à hauteur variable électrique, 2 parties
- Commande : Pédale
- Réglage de la tête en toutes positions par vérin à gaz
- Sellerie tendue plate de bonne densité 24kg/cm², non-feu classée M2, épaisseur 6cm
- Equipé d'un porte-rouleau pour drap d'examen côté pied
- Piètement acier peint époxy, coloris argent

DIMENSIONS

- Largeur 60cm
- Hauteur variable de 56 à 86cm
- Capacité de charge : 150kg en dynamique

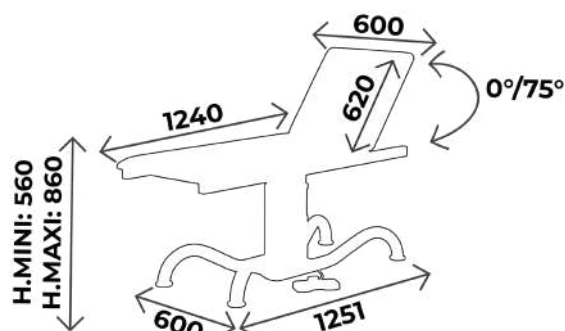

Vous aimerez aussi :

Réf. **SIMPLEX-2.0-700** : Idem SIMPLEX-2.0 mais largeur 70cm



À SAVOIR

- ✓ Délai : 15 jours à réception commande
- ✓ Garantie : 2 ans (1 an pour la sellerie)

ACCESSOIRES



ACC 990-SIMPLEX
Jeu de 4 roulettes jumelées
à frein diam. 75mm



ACC 76C
Étau unitaire
pour tige porte-sérum diam. 16mm



ACC 110
Gouttière prise de sang
Avec ferrure, sans étau, l'unité



ACC 105
Jeu d'étriers inox standard
diam. 14mm, sans étau



SLFEMIREPOSE
Housse préluède pour repose
jambes (ACC964), l'unité



ACC 54001
Têteière 1/2 lune largeur 60cm
revêtement non feu M1



ACCURGENCE03-60
Paire de barrières de lit
escamotables largeur 60cm



ACC 832
Trou visage avec bouchon



ACC 538
Jeu d'étaux diam. 14mm
pour SIMPLEX largeur 60cm



ACC 32012
Tige porte-sérum diam. 16mm
2 crochets plastiques, sans étau



ACC 110POLY
Gouttière prise de sang
polyuréthane avec ferrure
Sans étau, l'unité



ACC 964
Jeu de repose jambes noir,
sur rotule mousse polyuréthane,
diam. 14mm, sans étau



ACC 514-UNIVERSE
Protection plastique transparent
universelle



ACC TETERGO
Têteière ergonomique amovible



ACC BARRILITCOM
Paire de barrières de lit
escamotables

COLORIS SELLERIE

Sellerie non-feu
classée M2

Pour les coloris de sellerie, vous avez le choix entre la gamme ECOMAX, Classique et Urban
Attention ! coloris Classique et Urban **avec plus value**

Revêtement : Sellerie Gamme ECOMAX*



Galapagos



Bahamas

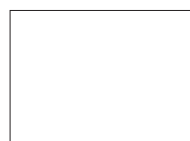

Blanc



Tahiti



Malouines

*Coloris standards pour gamme ECOMAX et SIMPLEX,
coloris Classique et Urban disponibles **sur demande**



COLORIS SELLERIE

Sellerie non-feu
classée M1

Attention ! coloris Classique et Urban avec plus value

Revêtement : Sellerie Gamme Classique



Arno



Garonne



Potomac



Amour

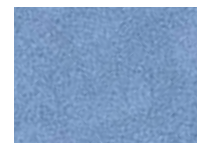

Mississippi



St Laurent

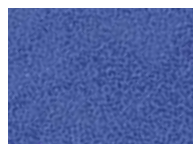

Rhône

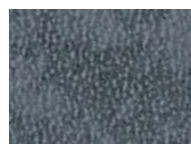

Missouri



Seine



Amazone

Revêtement : Sellerie Gamme Urban



Abysse

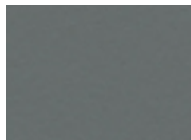

Cendre



Origan



Géranium

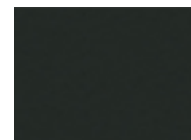

Réglisse



Prune

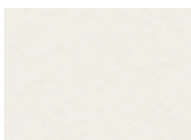

Perle

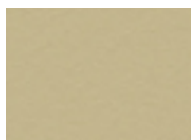

Ficelle

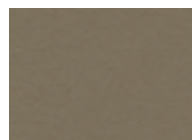

Terre

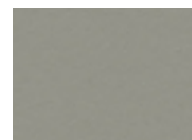

Béton

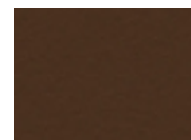

Chataigne

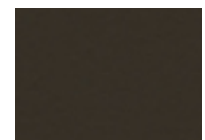

Chocolat

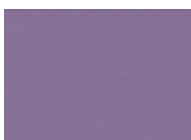

Pensée



Pétrole



Turquoise



Granny



Absinthe



Ananas



Orange



Fuschia



Tomate



GUIDE D'ENTRETIEN

ENTRETIEN QUOTIDIEN

- Sellerie : nettoyage à l'eau savonneuse uniquement (solvants proscrits), peut être désinfecté avec des produits tels que Phagosept Spray, Salvanios pH10 à 0,75% et Anios Surfaces Hautes, sans matière abrasive
- Piètement : nettoyage à l'eau savonneuse uniquement (solvants proscrits) sans matière abrasive

GARANTIE

- Châssis : 2 ans
- Sellerie : 1 an



CONTACT

CARINA
Médical

Parc d'entreprises Visionis
278 rue de l'industrie
01090 GUÉREINS- FRANCE

SERVICE COMMERCIAL

Tél : +33(0)4 74 66 69 49
Fax : +33(0)4 74 66 69 50
commercial@carinamedical.com